



Eaton's Carter Model 60554 Hydrant Pit Valve is a family of valves that includes lanyard, air or dual air/lanyard operated pilot valves, with available defueling option.

60554 Hydrant Pit valves meet all the requirements of 4th Edition EI 1584, including the breakaway and strength requirements.

The basic hydrant pit valve consists of three basic parts, lower valve assembly, upper valve assembly (or API outlet adapter) and a pilot valve. The lower valve assembly contains an isolation valve which will allow the removal and servicing of the upper valve assembly and the pilot valve assembly while the pit valve is still installed. (See service manual SM60554 for proper instructions). The upper valve portion of the 60554 is furnished with a replaceable 4" API outlet adapter on standard configurations and most upper valve options. This minimizes replacement parts and allows for easy replacement of outlet wearing surfaces.

Model 60554 Hydrant Pit Valve is designed with soft closing features to minimize the propagation of surge into the upstream piping system during closure of the valve.

Features

- Standard aluminum two-piece upper half standard, replaceable stainless steel 4" API outlet adapter.
- Stainless uppers with replaceable 4" API outlet adapter optional.
- Standard inlet flange mates with 4-inch 150 lb. ANSI flange.
- Non-adjustable closing time is 2-5 seconds.
- Optional Pilotless Valve reduces maintenance costs. Lanyard, air, or dual air/lanyard operated pilot valves available (for small or large pit applications).
- Servicing valve provides means to remove the upper valve assembly and pilot valve assembly with the unit still installed.
- Dual pilot adds true deadman backup to coupler, same as air operated pilot. Hydrant valve is automatically closed at the end of the refueling operation.
- All seals are field replaceable.
- Large pressure equalizing valve in the outlet poppet.
- Defueling capability optional with any air or dual air/lanyard operated pilot.
- Ductile iron main valve body epoxy coated for corrosion protection.
- Main piston well guided to minimize piston seal wear.
- 10 or 20-mesh screen options available.

Model Descriptions

There are six basic hydrant pit valve and pilot option combinations to which various modifications may be added by inclusion of option letters as shown in the table below. The six basic combinations are as follows:

- 60554D - Lanyard operated pilot valve for manual on/off control. Valve allows flow in the fueling direction only.
- 60554V – Air or fuel operated pilot valve for deadman control. Capable of bi-directional flow.
- 60554X – Simple valve connector to be used with air or fuel operated 64230 and/or 64280 Remote Pilot Valve Actuators. Capable of bi-directional flow.
- 60554Y – (Dual Operation) Right Hand Quick Release Lanyard with simple valve connector to be used with air or fuel operated 64230 and/or 64280 Remote Pilot Actuators. Capable of bi-directional flow.
- 60554Y1 – (Dual Operation) Left hand quick release lanyard with simple valve connector to be used with air or fuel operated 64230 and/or 64280 Remote Pilot Actuators. Capable of bi-directional flow.
- 60554Z – (Dual Operation) Air operated pilot valve with Lanyard override for manual on/off control. Capable of Bi-directional flow.

Model 64230 pilot valve actuator



Model 64280 pilot valve actuator



Installation information

It is critical that the mating coupler (shown at right) be connected correctly and the pit lid is able to close completely. The hydrant valve's installation depth depends upon the brand of pit used. The thickness of the pit lid should be checked to be sure that it will clear the hydrant valve before setting the pit. Eaton cannot be responsible for changes in the pits. The dimensions shown are for reference only.

Dimensions are shown in inches.

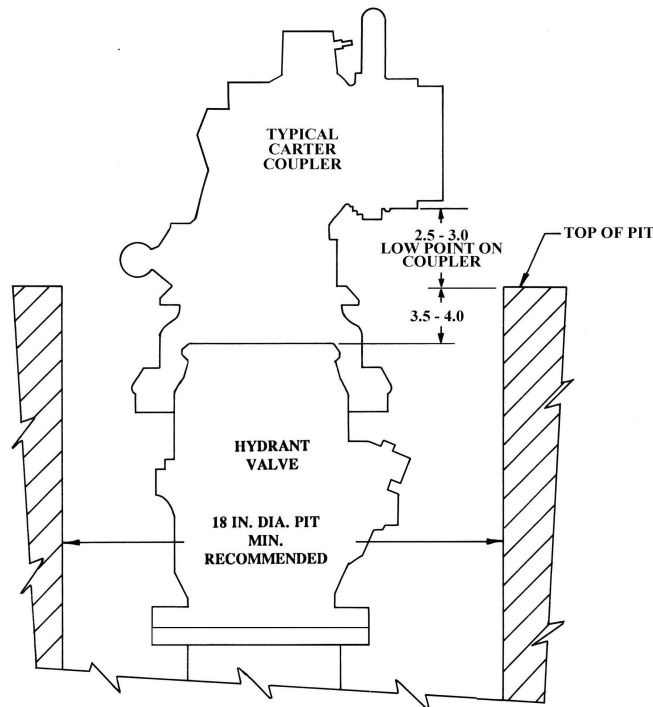

Dimensional specifications

The drawings below provide envelope dimensions for installation purposes only. They are not intended for inspection purposes.

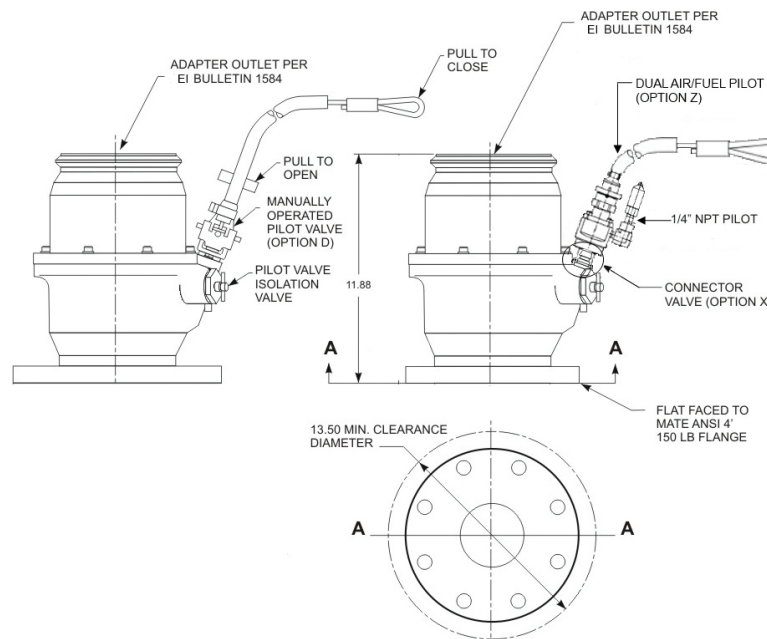

Technical information

- In compliance with EI 1584 4th Edition.
- Design Pressure: 275 psi (1900 kPa). Operating Pressure: -1.5 – 200 psi (-10 – 1400 kPa). Pressures are in accordance with EI 1584 4th Edition.
- Closing Time - 2 to 5 seconds.
- Overshoot - 60.0 gals (225 liters) maximum at 1200 USgpm (4500 l/min.).
- Pilot valve air or fuel pressure required for models V, X, or Y is 35 psi min. (2.41 bars). Pilot valve air pressure required for model Z is 35 psi min. (2.41 bars).
- Mates with all 4" EI 1584 style hydrant couplers.
- Standard Materials - Inlet housing ductile iron; Outlet housing A356-T6 aluminum with stainless steel mating API adapter; trim - stainless steel and aluminum alloy.
- Weight – Basic Hydrant Pit Valve with options (D, V, X, & Y) 57.5 lbs., with option (Z) 58.0 lbs., with option (S) 70 lbs.

Illustrated options

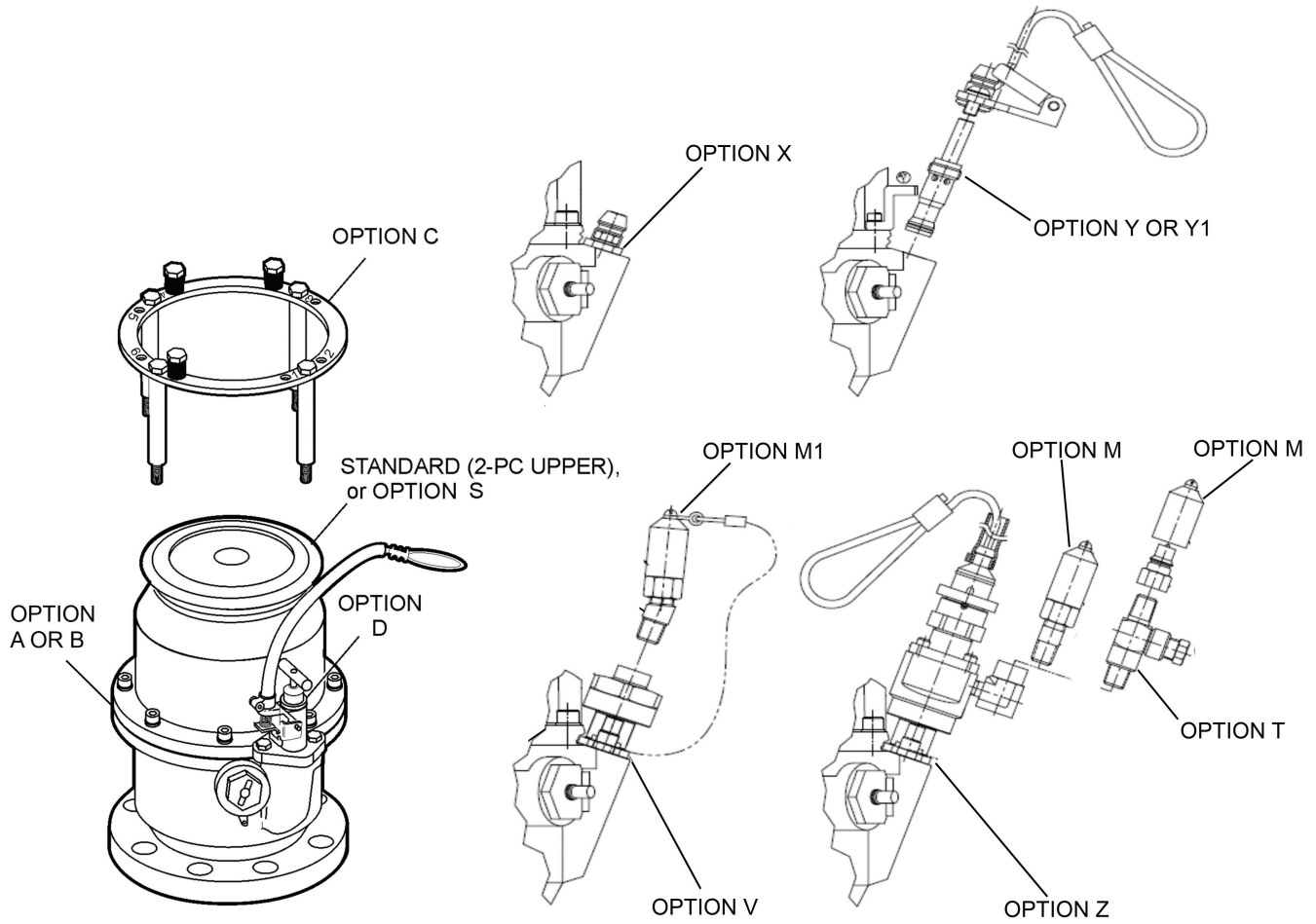

Ordering data

Option letters may be combined with the basic units, except as noted, to customize the valve to fit specific installation requirements. Note basic models referenced on page 2 “Model Description” section.

Option	Description
A	Adds 10-mesh screen between upper and lower halves of the unit. (81557-10)
B	Adds 20-mesh screen between upper and lower halves of the unit. (81557-20)
C	Adds six-position product selection (44290)
M	Adds Vented Male Disconnect to Option “Z” connection port.
M1	Adds Vented Male Disconnect with 15° fitting to Option “V” connection port.
S	Changes upper half housing (adapter) to 316 stainless steel. (43214-4) (Special order)
T	Adds Fusible Plug to connector port “Z” option. (47326).

Example: 60554BYM - Standard unit with dual operated pilot valve, vented male disconnect, and 20-mesh screen.

Superseding data

Since the late 1960’s, Eaton’s Carter product line of hydrant valves have been manufactured in a number of different designs and models. Several of these models are no longer manufactured and spare part support has been discontinued. The list of hydrant valve model numbers (right) provides the superseding

data to allow one to specify and procure the latest units of the series. Use this list to obtain the appropriate current model number (60554 or 61654) and then refer to the appropriate table of options for either model 60554 or 61654 hydrant valve to complete the part number. (For Model 61654 options, see brochure TF100-86).

Model Number	Description	Superseded by - Comments
60550	4” x 4” API Adapter with manual butterfly isolation valve at inlet.	No longer supported with spare parts. Replace with appropriate 60554 Hydrant Valve.
60551	4” x 4” API outlet adapter with dual flapper, lanyard operated inlet valve.	No longer supported with spare parts. Replace with appropriate 60554 Hydrant Valve.
60552	Same as 60551 except added interlock to close hydrant should coupler be inadvertently removed.	No longer supported with spare parts. Replace with appropriate 60554 Hydrant Valve.
60553	4” x 4” API outlet adapter with air operated inlet valve utilizing dual externally mounted cylinders.	No longer supported with spare parts. Replace with appropriate 60554 Hydrant Valve.
60554-1	Air operated 60554 type hydrant valve except 6” x 4” with outer housings and poppet material per ASTM A536-72, grade 80-55-06.	Spare parts common to standard 60554. For new orders use part number 61654V (Option K no longer offered.).
60554 SPECIAL/ 60554-2D/ 60554-3D	Same as 60554 Series except material for outer housings per ASTM A395.	Limited spare parts support continues. Contact Eaton Carter distributor for new order inquiry.
60555	Aluminum inlet to mate 6” 300 lb. flange x 4” API outlet. In accordance with IP Standard.	Spare parts support continues for all parts except inlet housing. Inlet housing can be replaced with a kit of current ductile iron parts.
61153	6” x 4” - 300 lb. flange inlet with API outlet adapter. Air operated pilot with defueling capability and 10-mesh screen.	Spare parts support continues. For new orders use part number 61654AV. (Part number change only).
60554E	4” x 4” hydrant valve with air operated pilot.	Spare parts support continues. For new orders use part number 60554V.
60554F	4”x 4” hydrant valve with dual air/lanyard pilot valve.	Spare parts support continues. For new orders use part number 60554Z.
60554J	4” x 4” hydrant valve with air pilot and defuel capability.	Spare parts support continues. For new orders use option X, Y, Y1, V, or Z combined with 60554 hydrant pit valve.
60554Q and 60554R	4” x 4” hydrant valve with ductile upper housing and ductile API 4” adapter (option Q) or stainless steel API 4” adapter (option R).	Spare parts support continues. For new orders use option S for full stainless steel upper housing assembly.
60554U	4” x 4” hydrant valve with dual air/lanyard pilot valve.	Spare parts support continues. For new orders use option Y, Y1, or Z combined with 60554 hydrant valve.

Valve operation

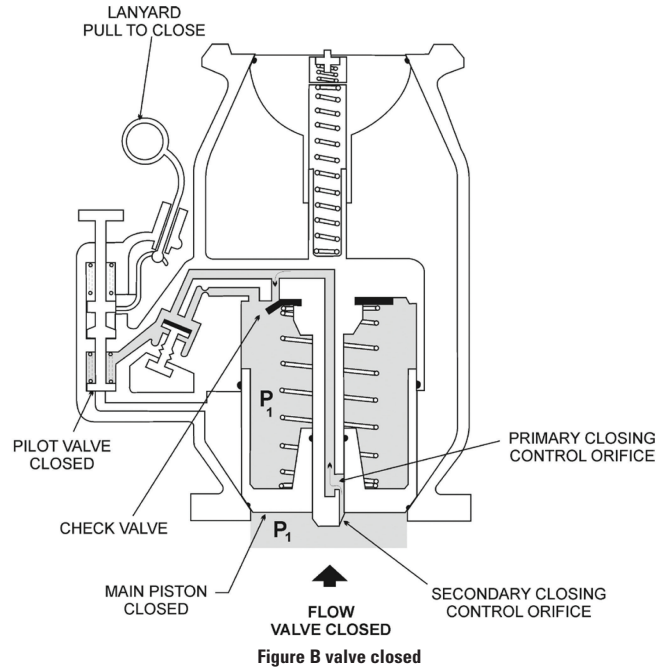
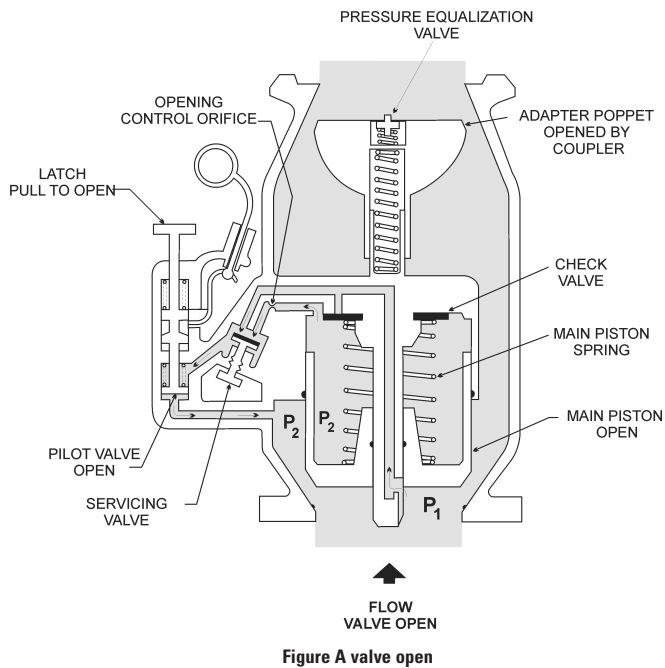

Figure A reflects a lanyard operated pilot valve shown in the open position. Figure B reflects a lanyard operated pilot in a closed position. The operation of the Hydrant Valve, whether the pilot is lanyard, air, or fuel operated, is identical. The only differences are in the operating mechanism that supplies the pressure to open and close the pilot valve. In the air or fuel operated pilot, the closing lanyard and opening latching mechanisms are replaced with an air or fuel operated piston. The dual air/lanyard operated pilot valve has the same normal air operated pilot valve function with a manual (lanyard) over-ride of the air supply.

Servicing valve closed/Pilot valve open or closed

Closing of the Servicing Valve has the same effect as closing the Pilot Valve. That is, the flow passage from the piston chamber to the downstream side of the piston is blocked. The piston chamber pressure begins to equalize to the inlet pressure (P1) through the check valve. The piston area is greater than the effective seal area, hence the unbalance of forces caused by the equal pressure, plus the spring, will cause the valve to stay closed.

Pilot valve open/Servicing valve open

The open pilot valve allows the continuous passageway from the main piston chamber and from the closing control orifice. The piston chamber is vented through an opening control orifice and the open Servicing valve to a point in the Lower Valve Half. The pressure (P2) at this point is less than the inlet pressure (P1). The piston chamber pressure is also maintained at P2 causing an unbalance of forces on the piston. The inlet pressure force is greater than the combined piston pressure force plus the spring force hence the valve will open to allow flow. This is assuming that the outlet adapter poppet in the Upper Valve Half has been opened by a Coupler.

The pilot poppet is maintained in the open position by one of two methods:

- Lanyard operated pilot - The pilot is opened by the pull of the "T" handle located on the top of the pilot valve. When it is pulled upward, the spring loaded latch attached to the lanyard pivots to lock the pilot into the open position.

- Air operated pilot/dual air-lanyard pilot - Air pressure applied to the pilot piston will maintain the pilot in the open position until the pressure has been depleted (by release of deadman or pulling lanyard).
- Air or fuel operated pilot - Pressure applied to the pilot piston will maintain the pilot in the open position until pressure has been depleted (by release of deadman).

Pilot valve closed/Servicing valve open

Pulling the lanyard, or depleting the air or fuel pressure supplied to their respective pilots, will allow the spring loaded pilot poppet to close. This action blocks off the venting of the piston chamber to the lower pressure area downstream. The piston chamber begins to equalize to the inlet pressure (P1) through the check valve.

The piston area is greater than the effective seal area; hence the unbalance of forces caused by the equal pressure plus the spring will cause the piston to begin to close. As the piston moves toward the closed position, the piston chamber volume increases and must be filled through the two series orifices. The primary orifice is considerably larger than the secondary (slot). During the initial and majority of the travel of the piston, the primary orifice is fully exposed to the inlet pressure; hence the rate of closure is controlled by this orifice.

When the piston moves far enough closed to cover the primary orifice, the secondary (smaller) orifice begins to control the closure rate. Hence the valve begins to close relatively rapidly and then slows down as it nears its closed position. The relative size and locations of these two orifices allows the valve to close to provide a minimum of overshoot and yet limit the surge pressure shock, on closing, and still maintain a closure rate in accordance with applicable international specifications.

On defueling options the pilot valve remains closed so long as the pilot is not actuated manually or by deadman supplied pressure.

The lanyard operation is only for emergency situations where the air supply is not released by the deadman valve.

Technical data

Flow characteristics

The charts presented below depicts typical pressure drop versus flow characteristics of the 60554 Series Hydrant Pit Valves. (Pilot option D, X, Y, Y1, V, or Z will not alter the pressure drop characteristics of the 60554).

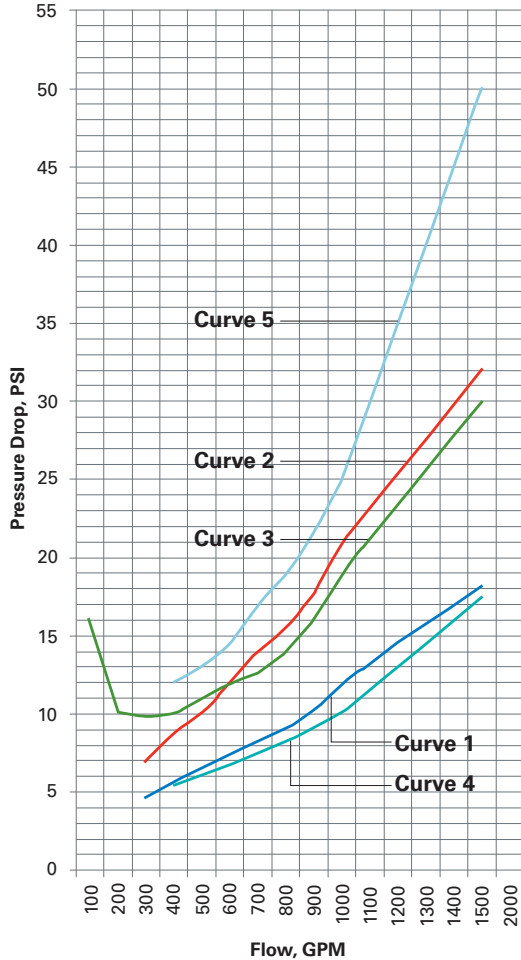

- Curve 1** Model 60554BD - 20-mesh screen & 61525.
- Curve 2** Model 60554X, 20-mesh screen & 61525 - fueling direction.
- Curve 3** Model 60554X, 20-mesh Screen & 61525 - defueling direction.
- Curve 4** Model 60554D no screen and Model 61525 Coupler
- Curve 5** 60554D - no screen & 60600K.

Technical data

60554ST1 Hydrant outlet wear gauge

Wear gauge is available to check for wear on the 4" API adapter interface of Carter hydrant valves made in accordance with EI 1584 4th Edition. Refer to the appropriate service manual for instructions.

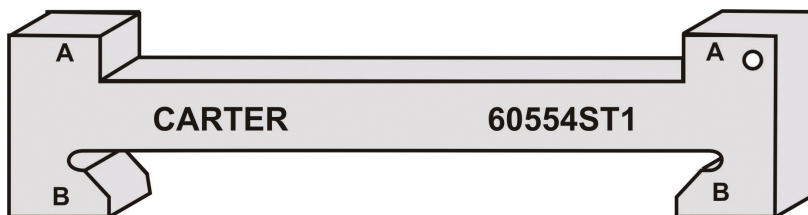



Eaton
1000 Eaton Boulevard
Cleveland, OH 44122
United States
Eaton.com

Electrical Sector
Canadian Operations
5050 Mainway
Burlington, ON L7L 5Z1
Canada
EatonCanada.ca

© 2018 Eaton
All Rights Reserved
Printed in USA
January 2018

Eaton is a registered trademark.

All other trademarks are property
of their respective owners.

Follow us on social media to get the
latest product and support information.

